

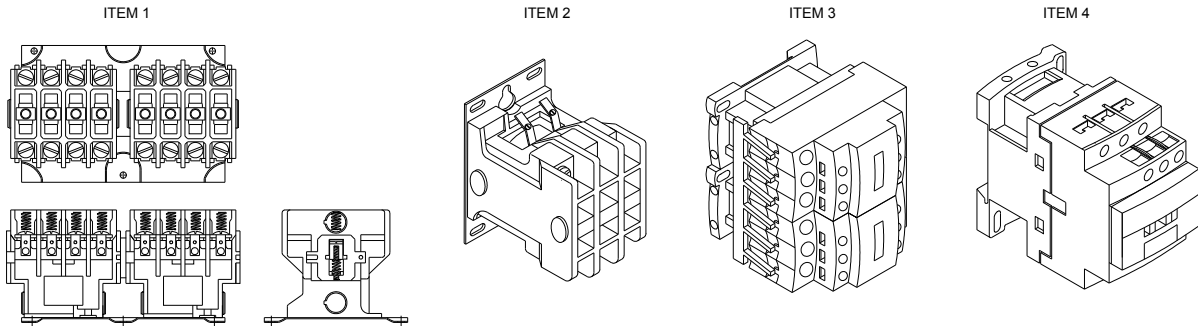

Tower Panels

Contactors



Ref.	Original Part No.	Substitute Part No.	Description
1	09-0864-0		Contactors, 4 Pole, Reverse, Interlock
2	09-0866-5		Contactors, 3 Pole, Tower Control
3	11-8921-0		Contactors, 3 Pole, Reverse, MI, w/AUX
4	14-8895-0		Kit, TB Contactor, Replacement

Relays

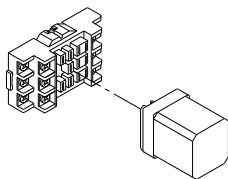

9-9182-8 SOCKET, 11 BLADE, SQ. DIN RAIL MNT. (B.P.)
9-9245-3 RELAY, 3PDT, ENCLOSED, 120 VAC

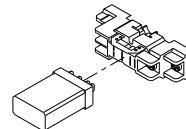

10-0061-1 SOCKET, RELAY, PLUG-IN, 5 BLADE, 300 VAC
10-0060-3 RELAY, PLUG-IN, SING. PL/DBL. THROW

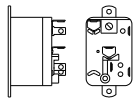

9-6812-3 RELAY, RBM #84-502-06-301

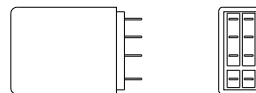

11-0015-5 RELAY, PLUG-IN, DBL. POLE DT, 120V

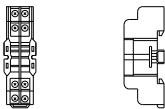

11-0016-3 SOCKET, RELAY, DPDT, 7AMP, 300V

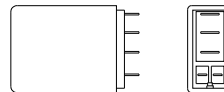

14-8540-0 RELAY, 24VAC, SPDT, PLUG-IN

Ref.	Original Part No.	Substitute Part No.	Description
1	09-9182-8		Socket, 11 Blade, Sq, Din Rain Mt.
2	09-9245-3		Relay, 3PDT, Enclosed, 120 VAC
3	09-6812-3		Kit, Relay, RBM w/Adaptor
4	10-0060-3		Relay, Plug-In, SPDT

Ref.	Original Part No.	Substitute Part No.	Description
5	10-0061-1		Socket, Relay, Plug-In, 300V
6	11-0015-5		Socket, Relay, DPDT, 120V
7	11-0016-3		Socket, Relay, DPDT, 7 AMP, 300V
8	14-8540-0		Relay, 24VAC, SPDT, Plug-in